



UNIVERSITY OF ILLINOIS
AT URBANA-CHAMPAIGN

ALMA MATER

TO THY HAPPY CHILDREN
OF THE FUTURE
THOSE OF THE PAST
SEND GREETINGS

AC Measurement of Magnetic Susceptibility. Part 2.

Physics 401, Fall 2019
Eugene V. Colla



Outline

- **What and how we measuring (week1)**
- **Magnetic losses**
- **Temperature dependencies of permeability**
- **End of semester**



Magnetic materials.

$$B = \mu_0 (H + M)$$

Magnetic induction

Permeability
of free space

Magnetic field

Magnetization

$$M = \chi \cdot H$$

χ – magnetic susceptibility



Magnetic materials.

$$B = \mu_0 (H + M)$$

$$M = \chi \cdot H$$

In general χ is a function of H and T

$$M = \chi(H, T) \cdot H$$

$$\chi(H, T) = \left(\frac{\partial M}{\partial H} \right)_T$$



Magnetic materials.

$$B = \mu_0 (H + \chi H) = \mu_0 (1 + \chi) H = \mu_0 \mu_r H;$$

$$\mu_r = 1 + \chi$$

$\chi < 0$	-	diamagnetics,	$\mu_r < 1$
$\chi > 0$	-	paramagnetics	$\mu_r > 1$
$\chi \gg 0$	-	ferromagnetics	$\mu_r \gg 1$



Magnetic materials. Diamagnetism.

Material	χ_v (10^{-5})
Bismuth	-16.6
Carbon (diamond)	-2.1
Carbon (graphite)	-1.6
Copper	-1.0
Lead	-1.8
Mercury	-2.9
Pyrolytic carbon	-40.0
Silver	-2.6
Superconductor	-10^5
Water	-0.91

$\chi < 0$ - diamagnetics

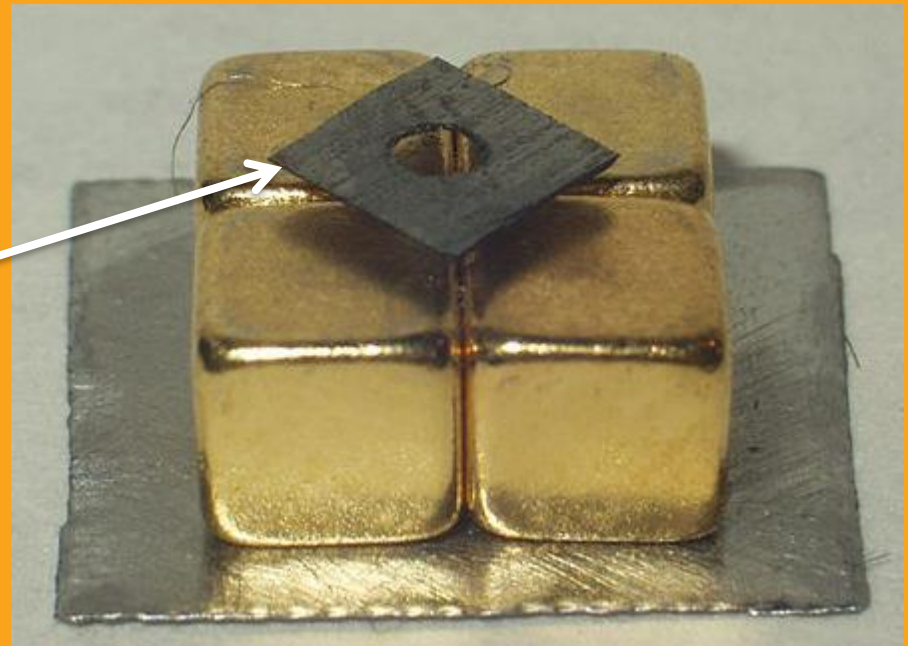

Levitation of the pyrolytic carbon

Ideal diamagnetic $\chi = -1$

Courtesy of Wikipedia

Magnetic materials. Ferromagnetism.

$\chi \gg 1$ - ferromagnetics

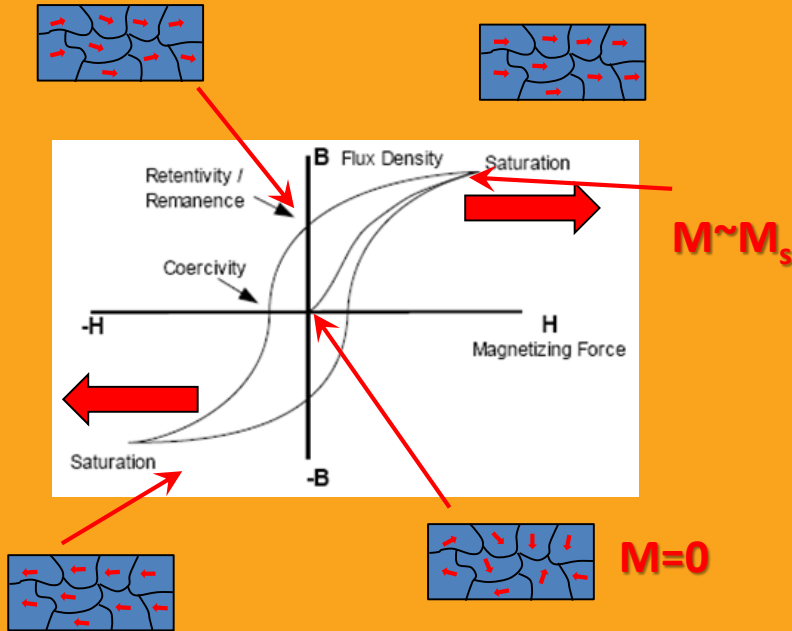

Material	μ_r	B_{rem} (T)
Fe, 99.8% pure	5000	1.3
Permalloy	100,000	0.7
Superpermalloy	1,000,000	0.7
Co, 99% pure	250	0.5
Ni, 99% pure	600	0.4

Measuring the permeability. DC field.

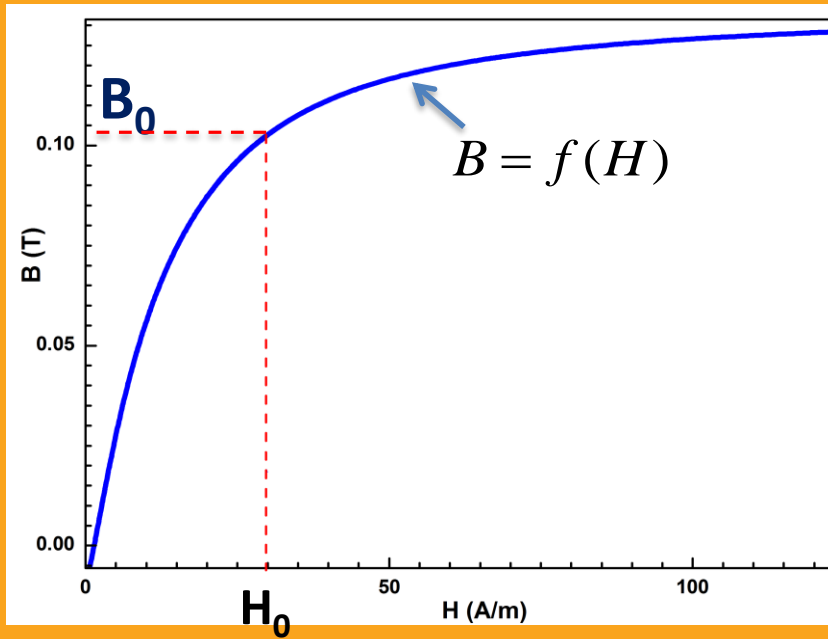

$$H = H_0 + H_1 \sin \omega t$$

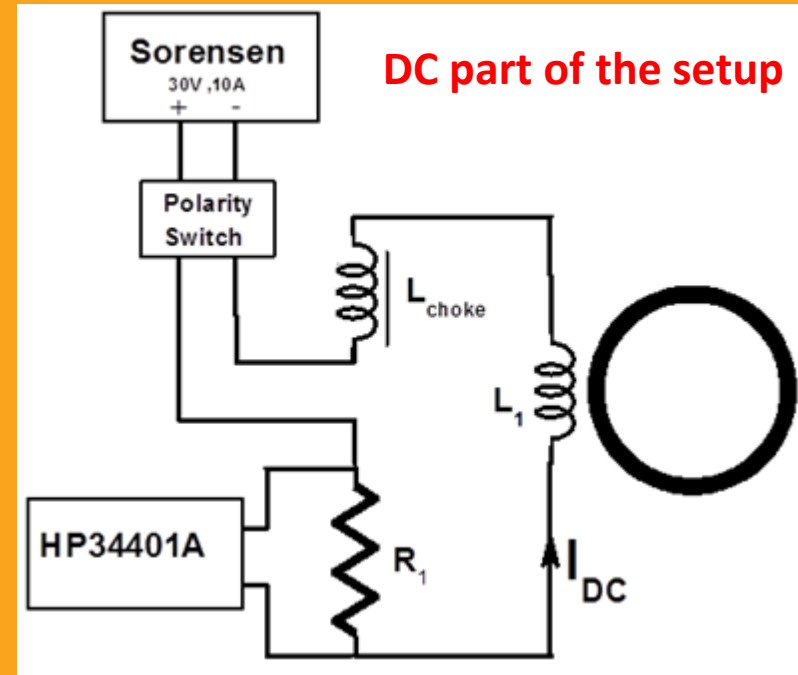

$$H_0 = \frac{N_p I_{DC}}{2\pi r}$$

Here N_p – number of turns in DC primary coil

Measuring of the permeability. AC modulation

$$H = H_0 + H_1 \sin \omega t$$

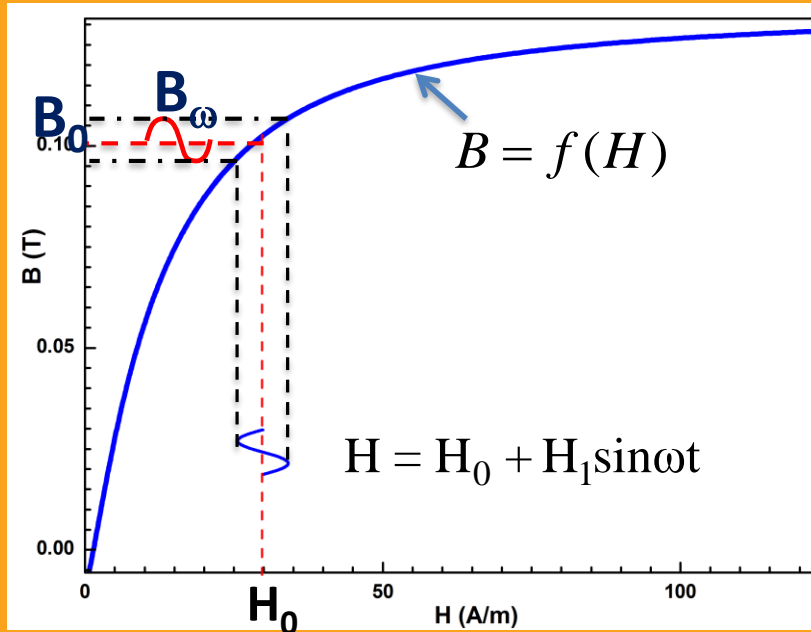

$$H_1 = \frac{N_p I_{AC}}{2\pi r}$$

$$B_\omega \sim \frac{df}{dH} = \frac{dB}{dH} = \mu = \mu_0 \mu_r$$

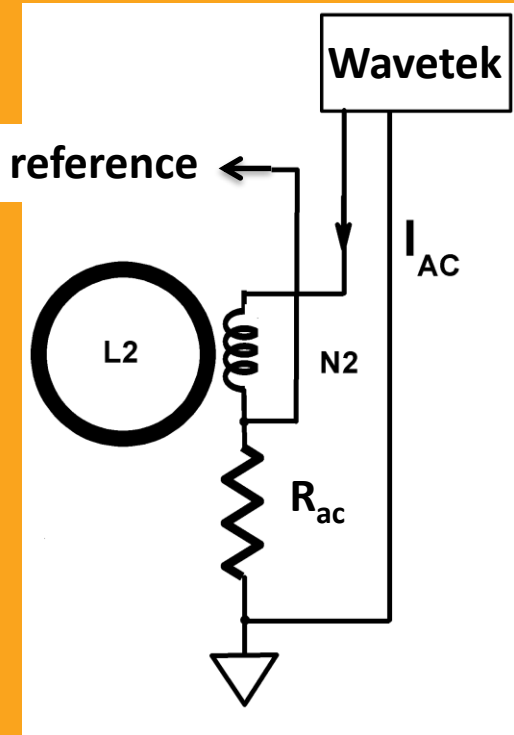

Here N_p – number of turns in AC primary coil

Measuring of the permeability. AC modulation

Primary coil of N_p turns supplied by current I_p creates magnetic field H and flux Φ

$$\text{For toroid: } H = \frac{N_p I_p}{2\pi r}$$

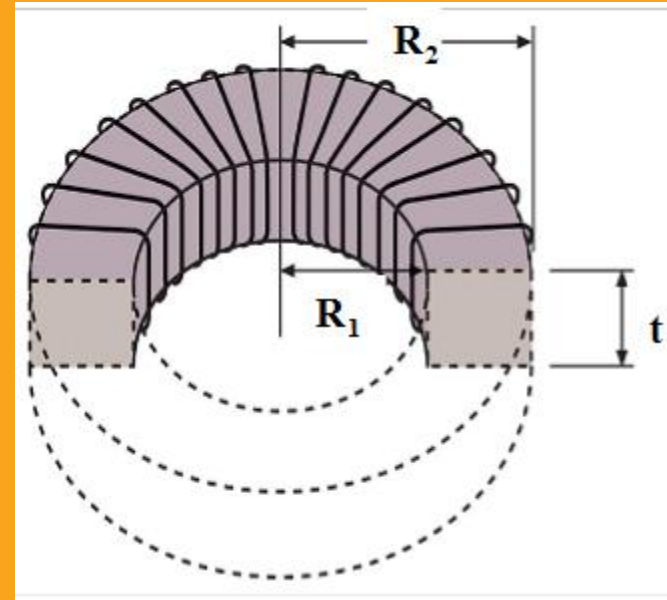

$$R_2 < r < R_1$$

$$\Phi = \mu \int \vec{H} \cdot d\vec{a} = \frac{\mu I N t}{2\pi} \int_{R_1}^{R_2} \frac{dr}{r} = \frac{\mu I N t}{2\pi} \ln \frac{R_2}{R_1}$$

$$da = dr \cdot t$$

Measuring of the permeability. Pickup coil.

Faraday's law

Lock-in measures emf on the pickup coil

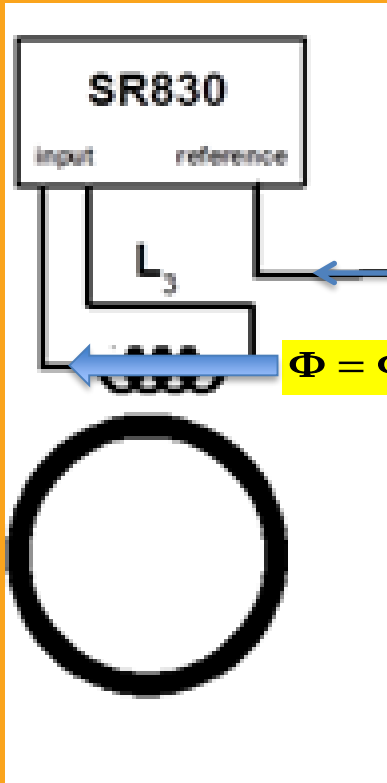

$$V_{lock-in} = -N_{pickup} \frac{d\Phi}{dt}$$

$$\Phi_1 = \int \vec{B}_{ac} \cdot d\vec{a} = \mu \int \vec{H}_{ac} \cdot d\vec{a}$$

$$\Phi_1 = \mu \int \vec{H}_{ac} \cdot d\vec{a} = \frac{\mu I_{AC} N t}{2\pi} \int_{R_1}^{R_2} \frac{dr}{r} = \frac{\mu I N t}{2\pi} \ln \frac{R_2}{R_1}$$

This is per 1 turn of the pickup coil !

Here I_{AC} is ac current in primary coil L3; $I_{AC} = \frac{V_0 \sin(\omega t)}{R_{ac}}$

$$V_{lock-in} = N_{pickup} \frac{\mu N t}{2\pi} \ln \frac{R_2}{R_1} \frac{dI_{AC}}{dt} = N_{pickup} \frac{\mu N t}{2\pi} \ln \frac{R_2}{R_1} \frac{V_{AC}}{R_{ac}} \omega \cos(\omega t) =$$

$$= \mu_r L_0 \frac{V_{AC}}{R_{ac}} \omega \cos(\omega t); \quad \text{where } L_0 = N_{pickup} \frac{\mu_0 N t}{2\pi} \ln \frac{R_2}{R_1}$$



Measuring of the permeability. Pickup coil.

$$V_{lock-in} = N_{pickup} \frac{\mu N t}{2\pi} \ln \frac{R_2}{R_1} \frac{dI_{AC}}{dt} = N_{pickup} \frac{\mu N t}{2\pi} \ln \frac{R_2}{R_1} \frac{V_{AC}}{R_{ac}} \omega \cos(\omega t) =$$

$$= \mu_r L_0 \frac{V_{AC}}{R_{ac}} \omega \cos(\omega t); \quad \text{where } L_0 = N_{pickup} \frac{\mu_0 N t}{2\pi} \ln \frac{R_2}{R_1}$$

In general $\mu_r = \mu' - j\mu''$

Geometry
of toroid

Resistor in
AC current
loop

Because of $\pi/2$ phase shift ($\cos(\omega t)$) the “ μ ” signal will be delivered to Y channel of the lock-in amplifier. μ'' provides the information about the losses in system

Hysteresis Loops. Remagnetization loses

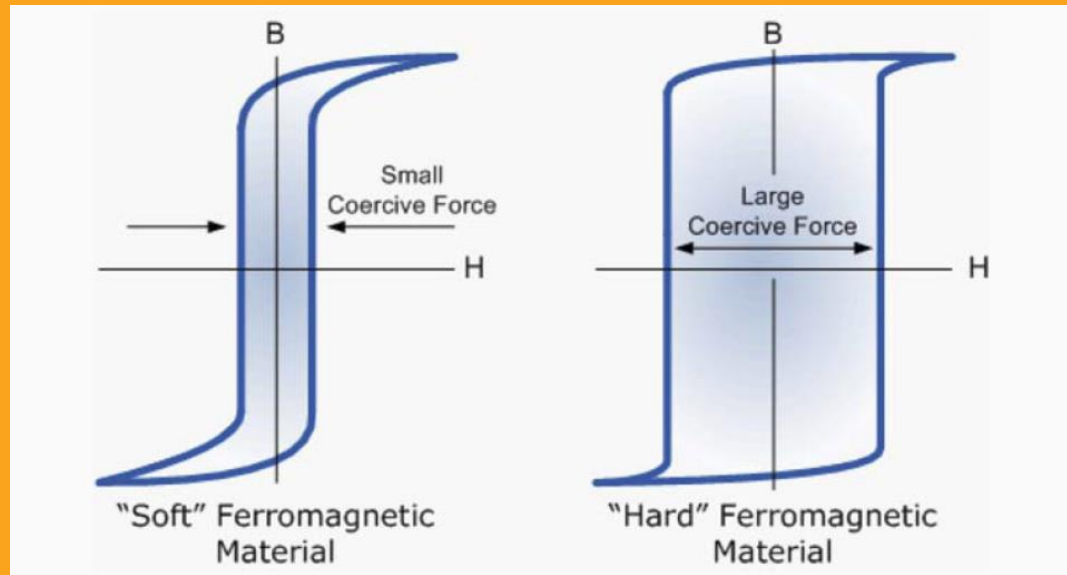

Energy of the magnetic field

$$W = V \int H dB$$

By cycling around the loop

$$W_{loop} = V \oint H dB = V * Loop_area$$

V here is a volume of the magnetic material

Calculating of the magnetic induction B

$$B = \mu_0 (1 + \chi) H = \mu_0 \mu_r H = \mu H$$

$$\mu = \mu_0 \mu_r = \frac{dB}{dH}; \quad B = \mu_0 \int \mu_r(H) dH$$

Magnetics ZP44715-TC

After integrating



Magnetics ZP44715-TC

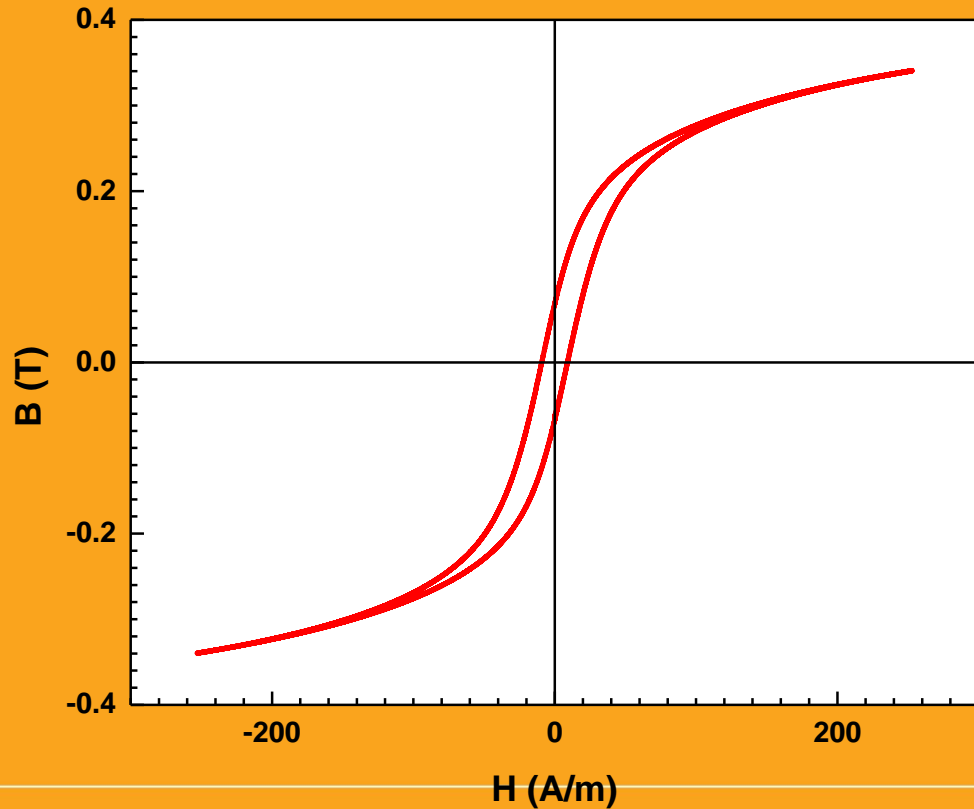

Hysteresis Loops. Remagnetization loses

$$W = V \int H dB$$

$$W_{loop} = V \oint H dB = V * Loop_area$$

Using Origin Pro for integrating

Magnetics ZP44715-TC

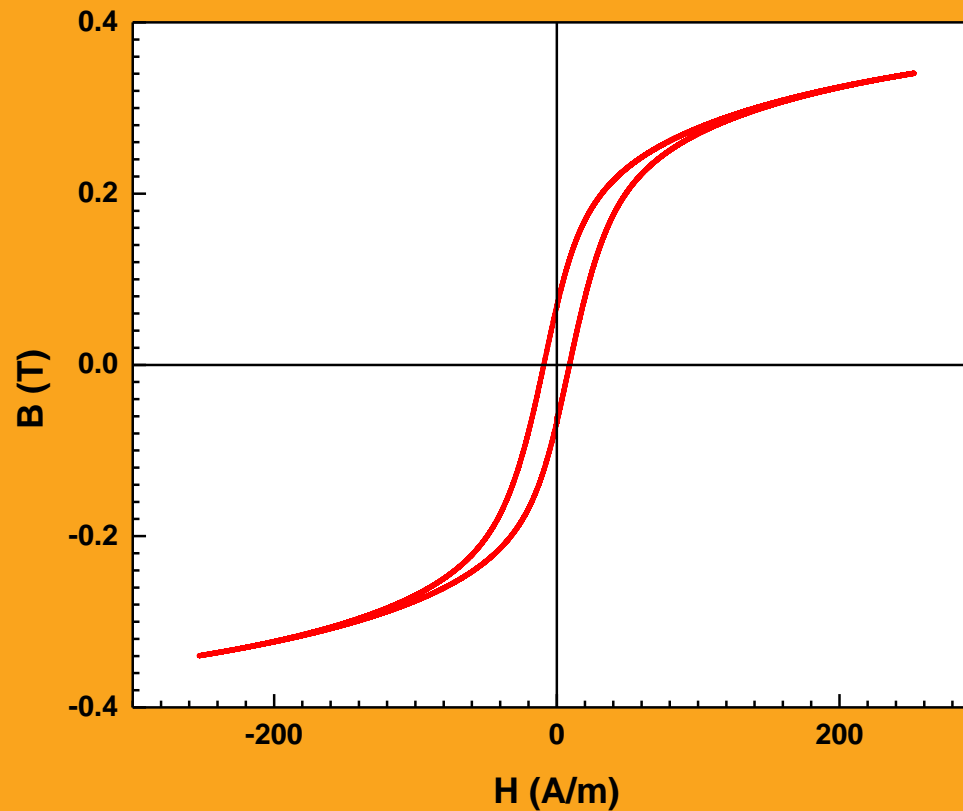

Hysteresis Loops. Remagnetization loses

$$W = V \int H dB$$

$$W_{loop} = V \oint H dB = V * Loop_area$$

Using Origin Pro for integrating

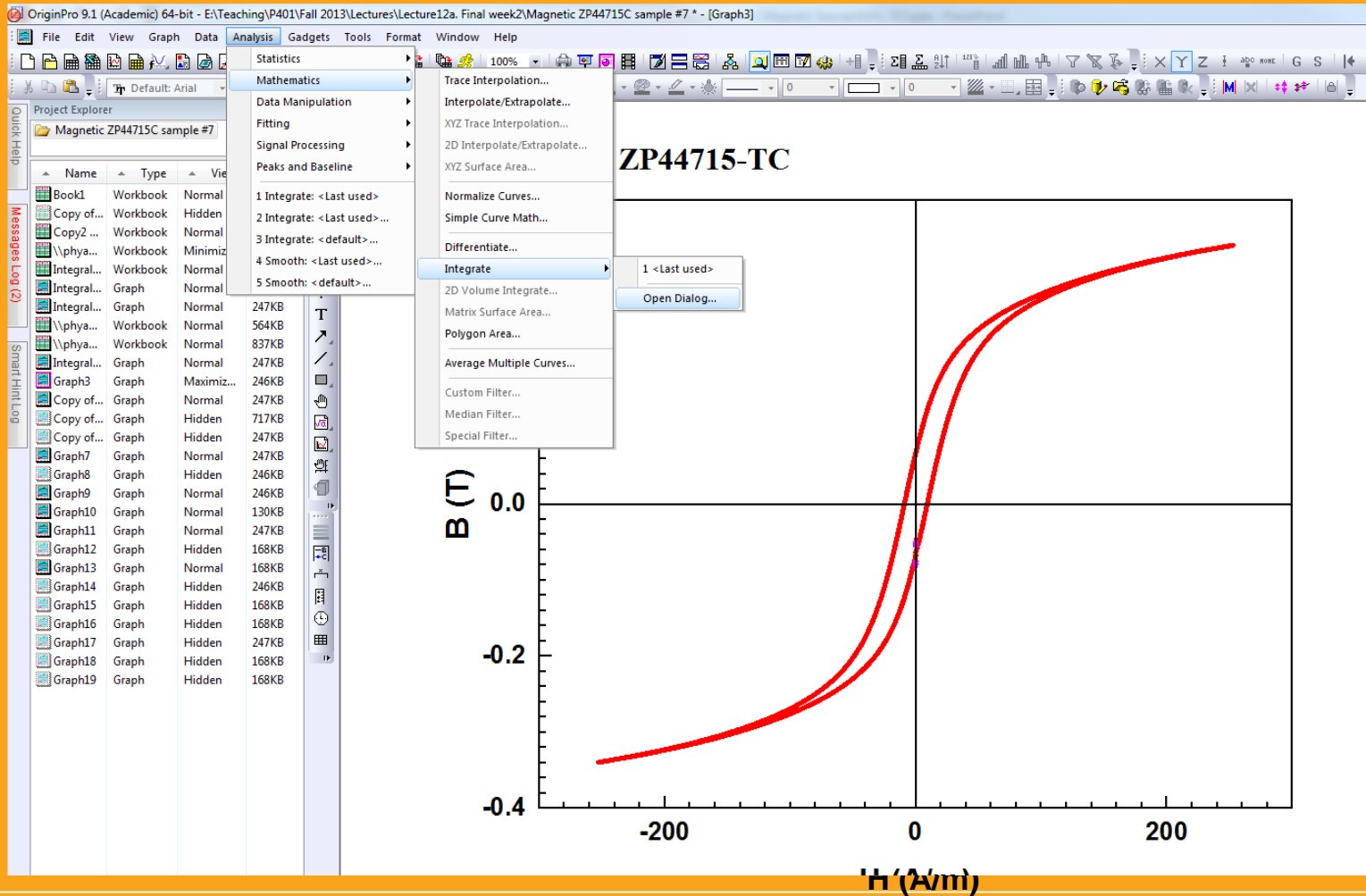

Hysteresis Loops. Remagnetization loses

$$W = V \int H dB$$

$$W_{loop} = V \oint H dB = V * Loop_area$$

Using Origin Pro for integrating

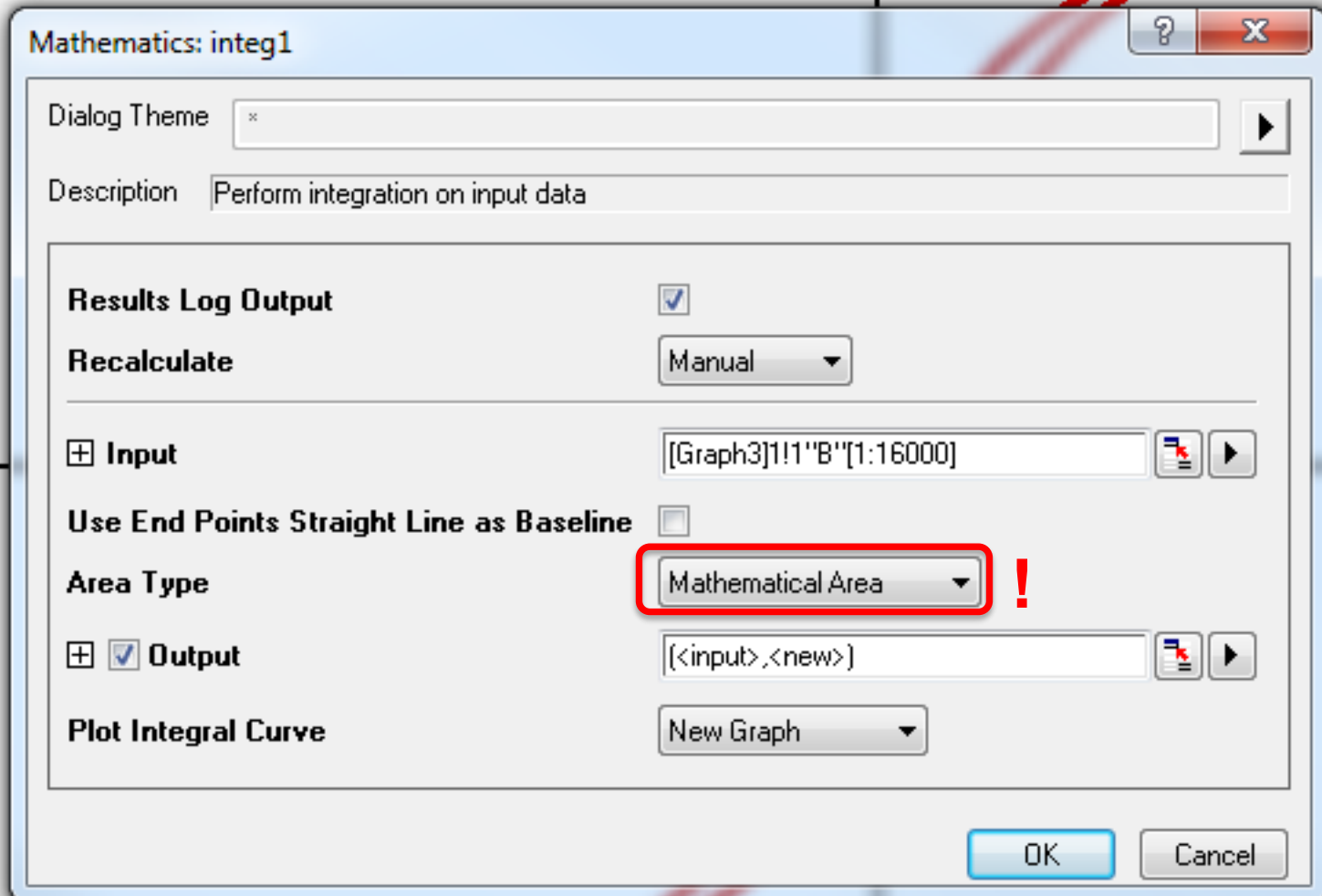

Hysteresis Loops. Remagnetization loses

$$W = V \int H dB$$

$$W_{loop} = V \oint H dB = V * Loop_area$$

Using Origin Pro for integrating

Magnetics ZP44715-TC

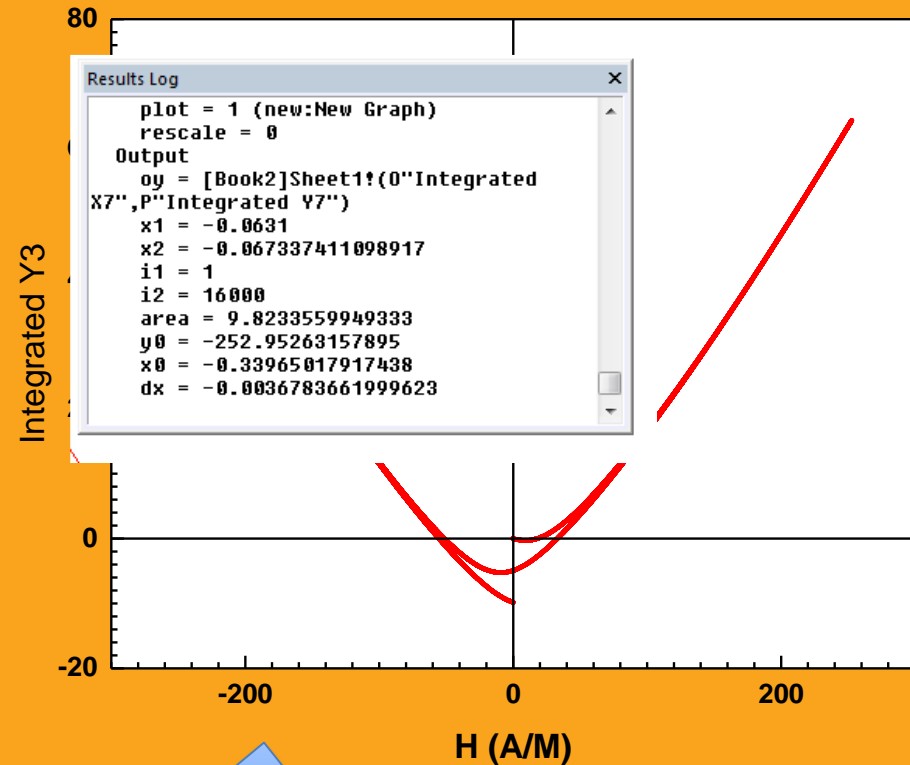
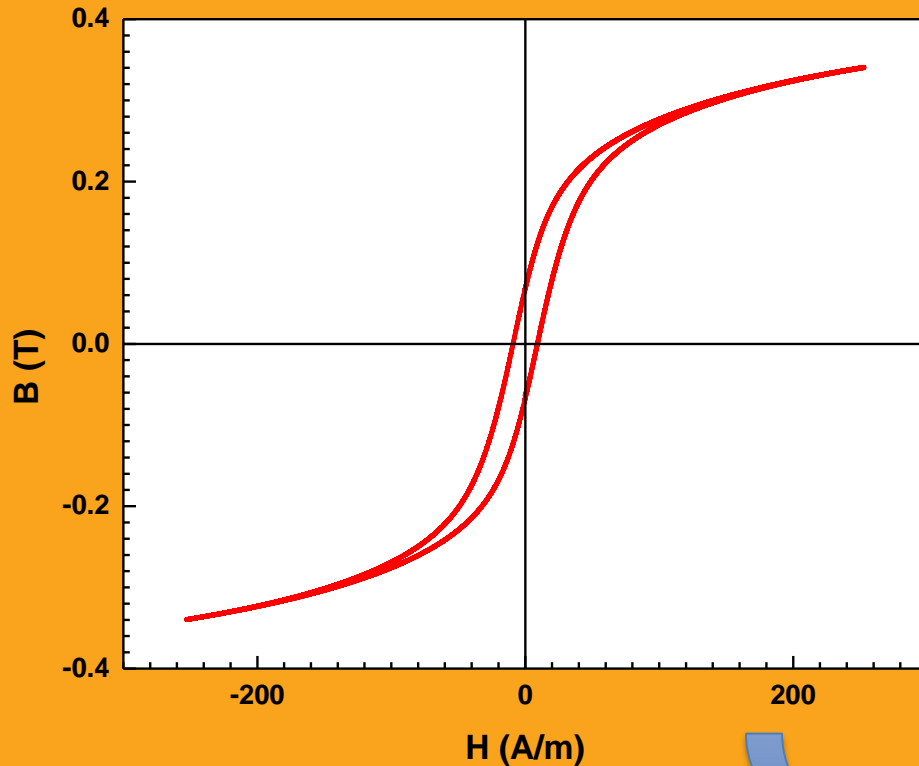

Hysteresis Loops. Remagnetization loses

$$W = V \int H dB$$

$$W_{loop} = V \oint H dB = V * Loop_area$$

Using Origin Pro for integrating

```
Results Log
plot = 1 (new:New Graph)
rescale = 0
Output
oy = [Book2]Sheet1!(0"Integrated
X7",P"Integrated Y7")
x1 = -0.0631
x2 = -0.067337411098917
i1 = 1
i2 = 16000
area = 9.8233559949333
y0 = -252.95263157895
x0 = -0.33965017917438
dx = -0.0036783661999623
```

Units :

$$V (\text{volume}) \rightarrow m^3$$

$$H (\text{field}) \rightarrow A \cdot m^{-1}$$

$$B (\text{magn.induction}) \rightarrow kg \cdot s^{-2} \cdot A^{-1}$$

$$[V \cdot B \cdot H] \rightarrow m^2 \cdot kg \cdot s^{-2} \equiv J (\text{joule})$$

Power of loses: $W/T = W * f$, where T is period and f frequency

Temperature dependence of the magnetic permeability.

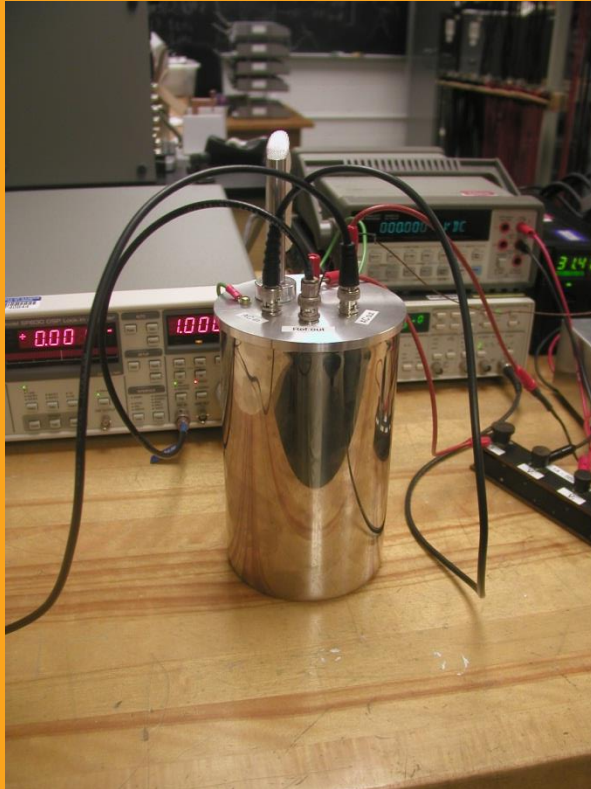

In this experiment we will measure permeability as a function of T . I_{DC} will be fixed. The default option $I_{DC} = 0$.

DMM will measure the emf of T-type thermocouple.

Measuring of the temperature. Thermocouple.

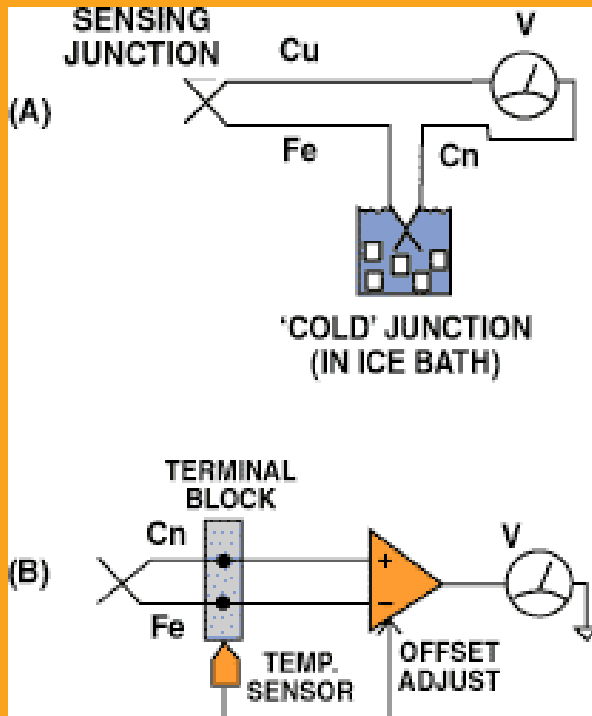

Type	Names of Materials	T Range
B	Platinum 30% Rhodium (+) Platinum 6% Rhodium (-)	2500 -3100F 1370-1700C
C	W5Re Tungsten 5% Rhenium (+) W26Re Tungsten 26% Rhenium (-)	3000-4200F 1650-2315C
E	Chromel (+) Constantan (-)	200-1650F 95-900C
J	Iron (+) Constantan (-)	200-1400F 95-760C
K	Chromel (+) Alumel (-)	200-2300F 95-1260C
N	Nicrosil (+) Nisil (-)	1200-2300F 650-1260C
R	Platinum 13% Rhodium (+) Platinum (-)	1600-2640F 870-1450C
S	Platinum 10% Rhodium (+) Platinum (-)	1800-2640F 980-1450C
T	Copper (+) Constantan (-)	-330-660F -200-350C

Type T (copper-constantan) has thermoemf at 0°C $41.5\mu\text{V}/^\circ\text{C}$;

Measuring of the temperature. Temperature ramp.

Option 1: manual by changing the voltage applied to the heater

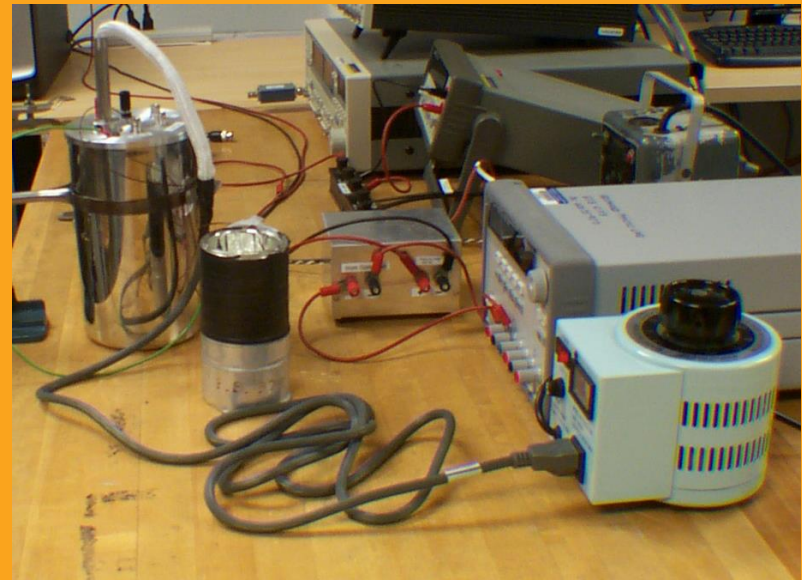

Option 2: by using Omega PID temperature controller



Measuring of the temperature. Software.

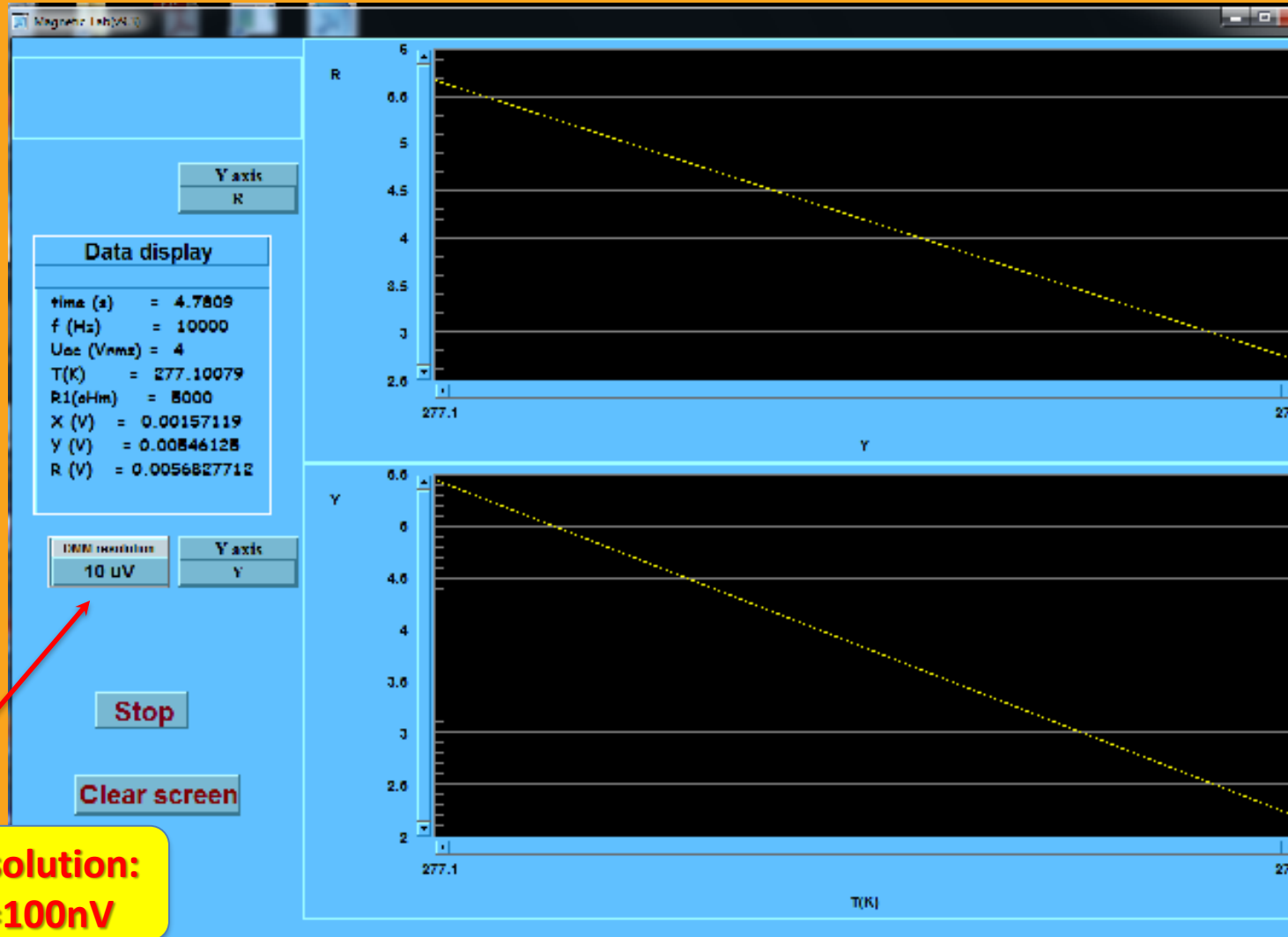

Temperature dependence of the magnetic permeability.

Ferroxcube 3E8

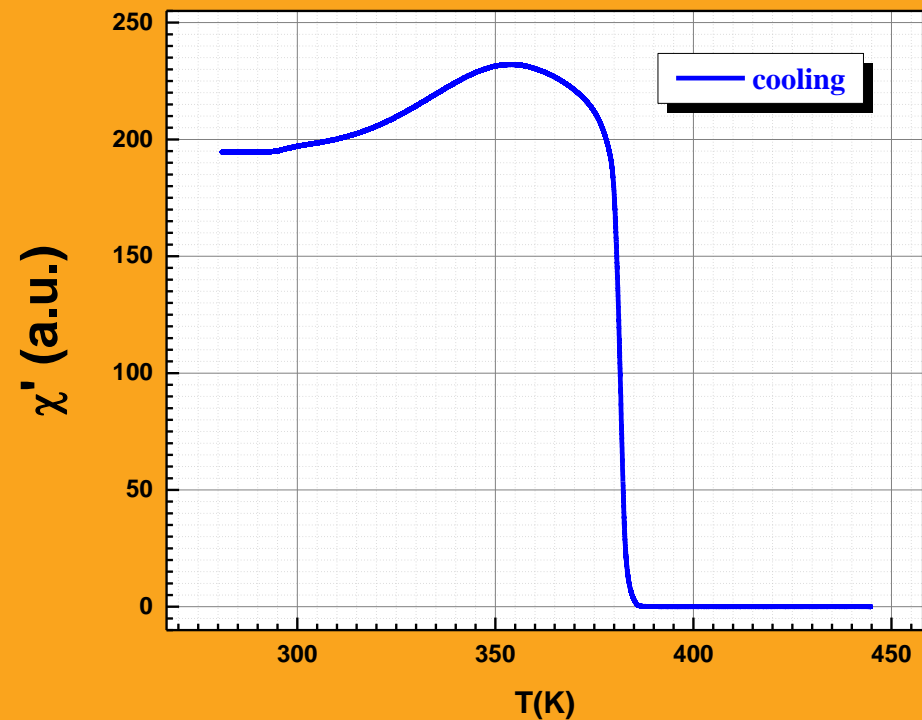
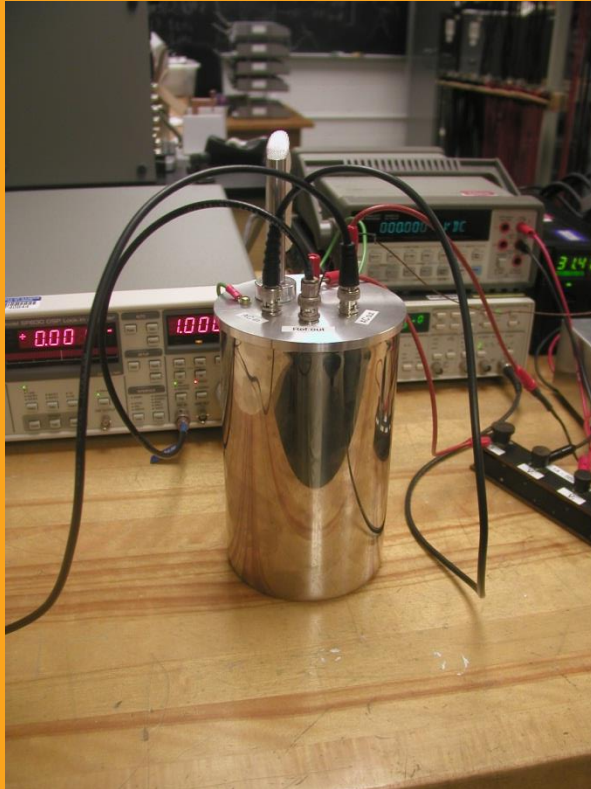

Temperature dependence of the magnetic permeability.

Ferroxcube 4A20

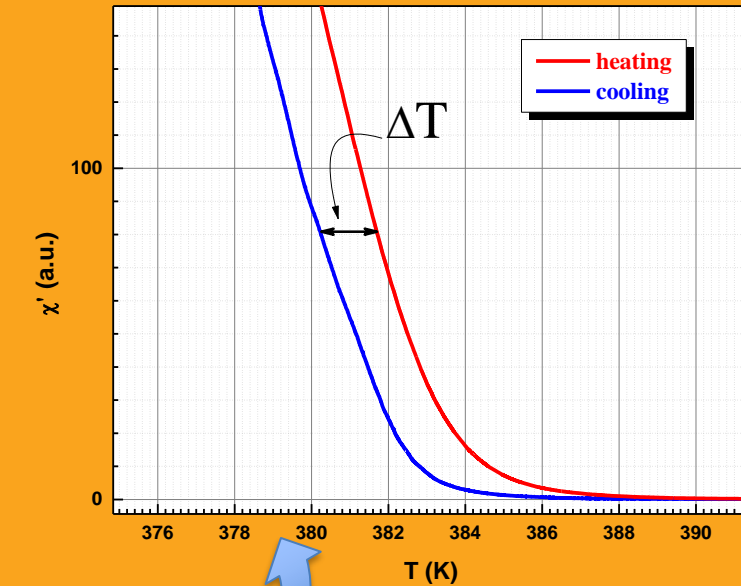
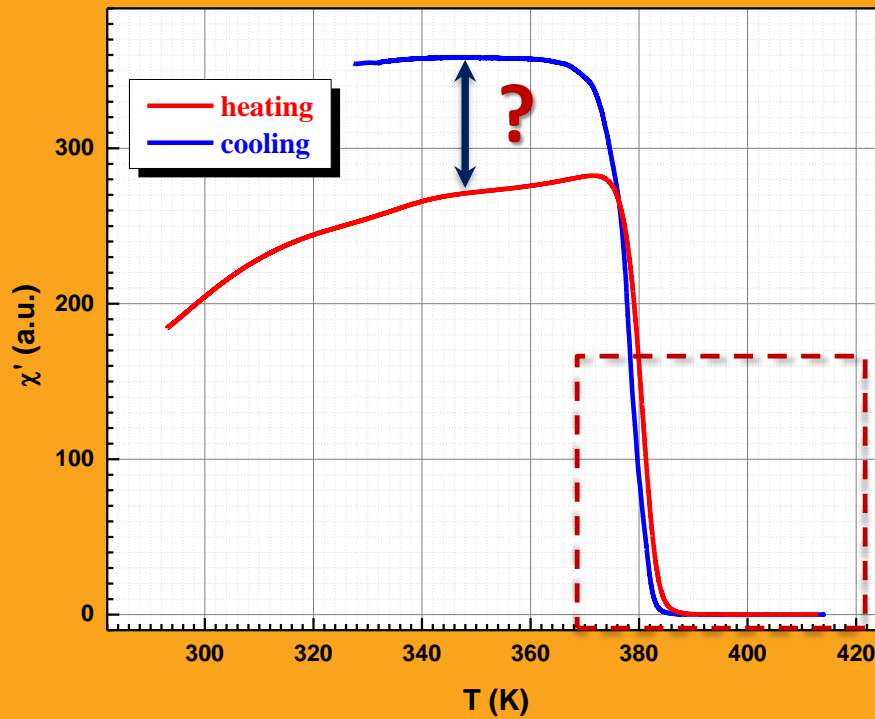

Hysteresis. Where it is coming from?

Temperature dependence of the magnetic permeability.

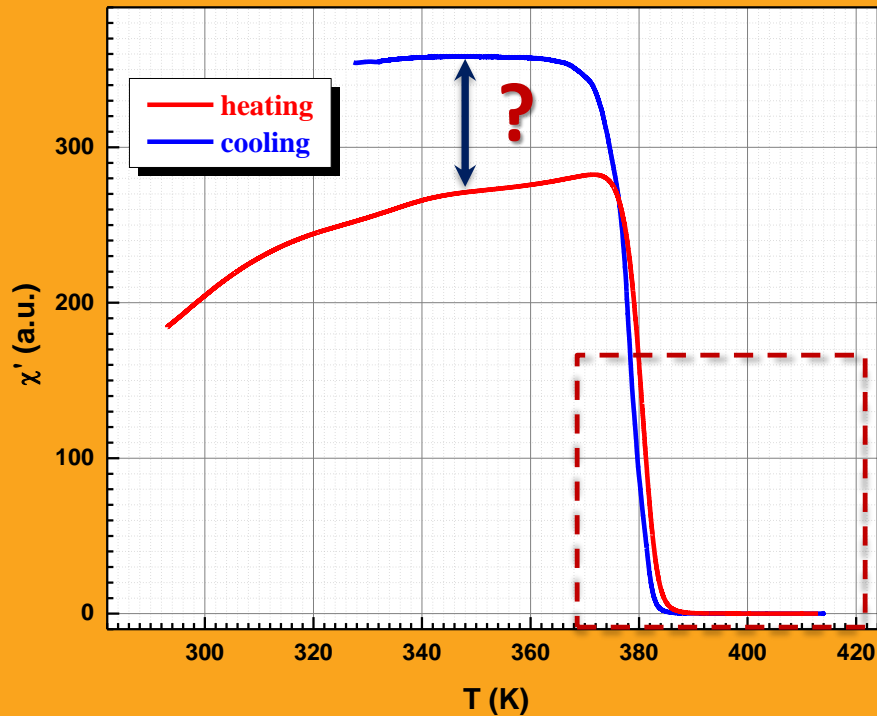

$$\mu(T) = \mu_0 \mu_r(T) = \frac{dB}{dH}(T)$$

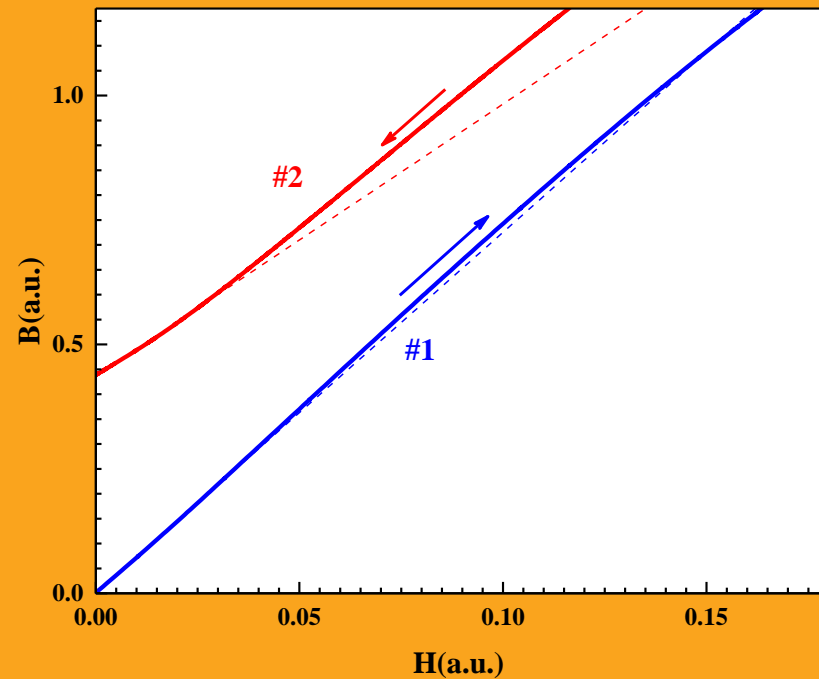

Slope#1 ~ 0.728

Slope#2 ~ 0.546

Temperature dependence of the magnetic permeability. Curie-Weiss law.

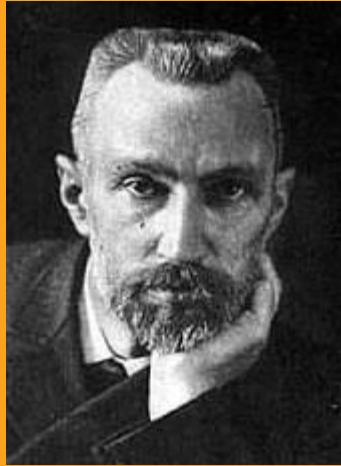

Pierre Curie
5.15.1859-4.19.1906

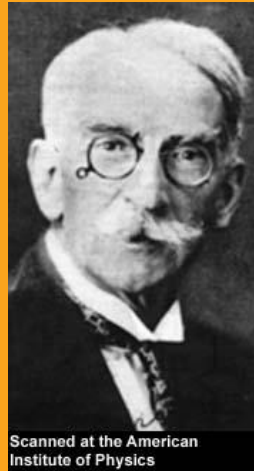

Pierre Ernest Weiss
3.25.1865-10.24.1940

$$\chi' = \frac{C}{T - T_c}$$

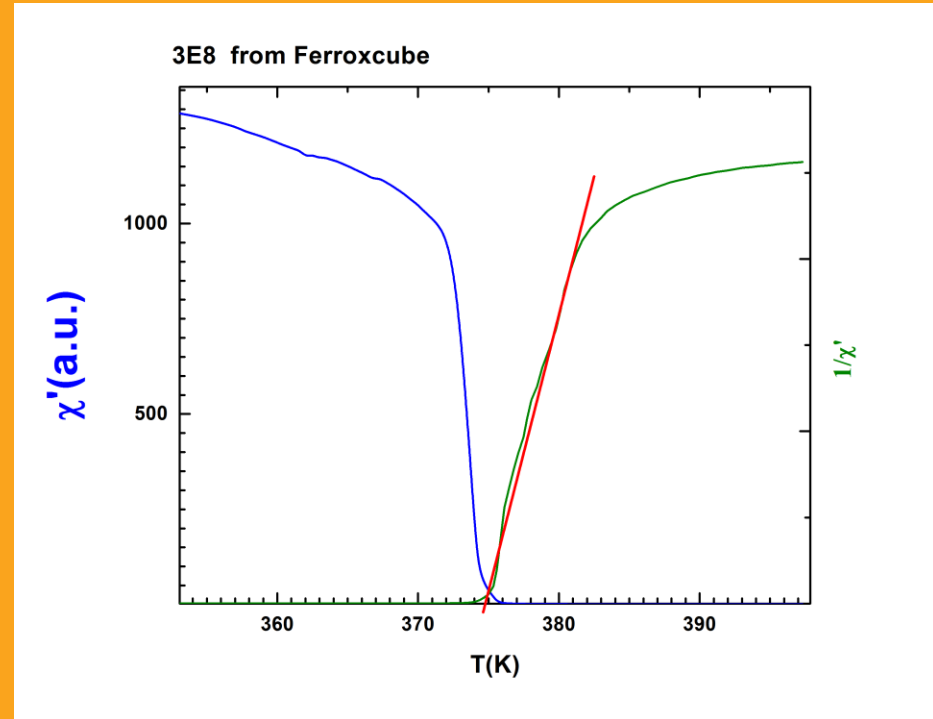

Curie-Weiss law

Temperature dependence of the magnetic permeability (week 3)

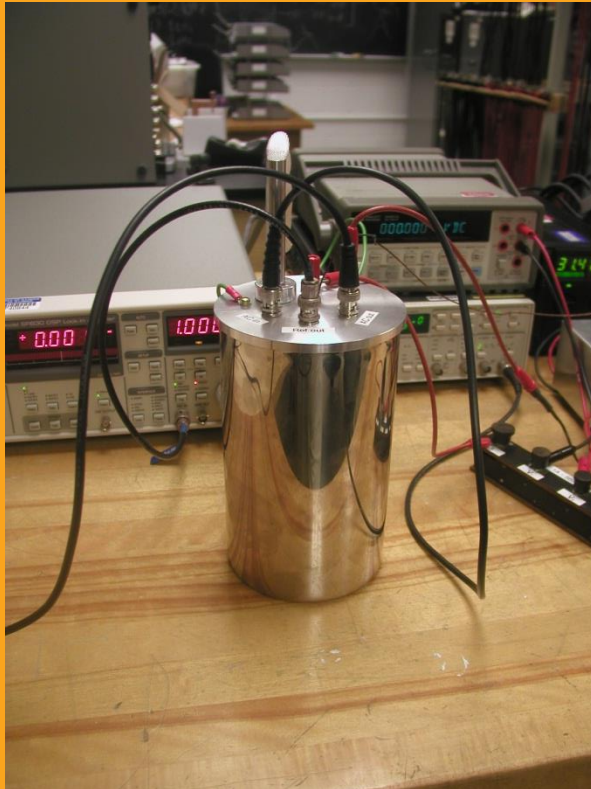

Ferroxcube 3E8

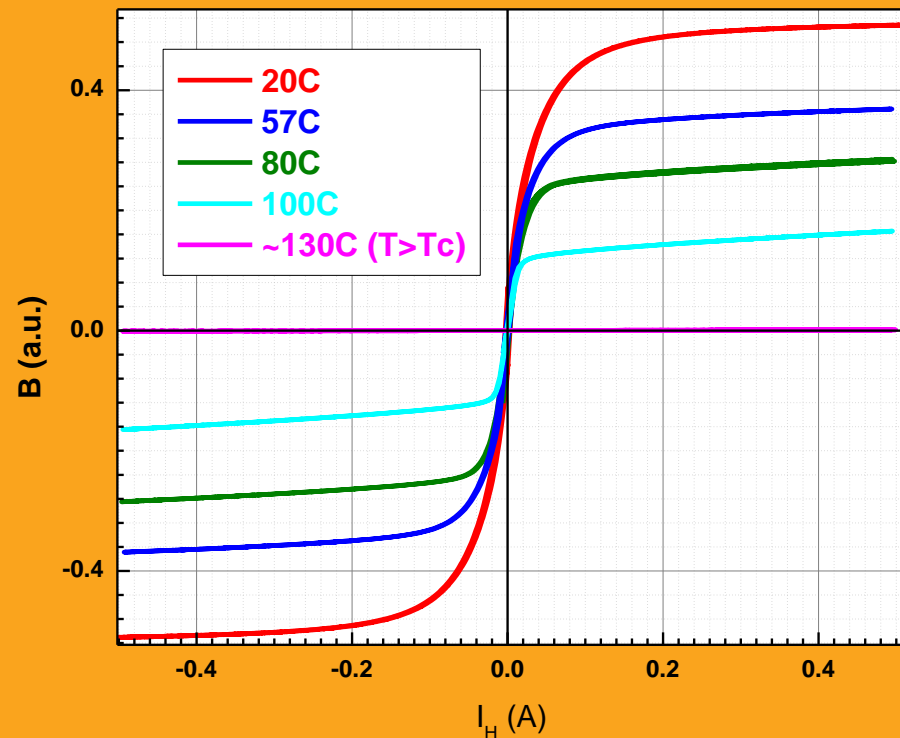

References

- **Information about magnetic materials can be found in :**
\\Phyaplportal\PHYCS401\Experiments\AC_Magnetization\Magnetic Materials
- **SR830 manual *ibid***



End of semester schedule

- **No Lectures on December 2nd and December 9th**
- **Third week of the Magnetic Laboratory. You can repeat some experiments done during first two weeks + some new challenging experiments like taking B-H dependencies taken at different temperatures or measuring of the permeability as a function frequency with and without DC magnetic field bias.**
- **December 15th Sunday 11.59pm. Final deadline for submitting of the final and resubmitted reports. No extension and no late vouchers!**

